



FOX

ROTARY LIMIT SWITCH

Fox is a device used to control the movement of industrial machinery when in need of measuring the movement on the basis of the rotation angle and/or of the number of shaft revolutions. Fox is made up by a gearmotor which transfers the movement to the cams and to the other movement detection devices placed inside it through a primary input reduction step (worm gear and helical toothed gear) and one or more secondary output steps (pairs of straight toothed gears).

Fox is used on wind turbines to control the position of the nacelle or the pitch angle of the blades. The motor that controls the rotation of a wind turbine on the yaw axis (or of the blade around its longitudinal axis) transfers the movement to the limit switch. A rotary encoder reads the rotation of the shaft, and its pulses are sent to a PLC which controls the position of the nacelle or of the blade. The movement of the shaft is also transferred, through a gearmotor, to a series of cam switches: the appropriate setting of the actuating point of the cams can signal up to four critical positions of the movement of the nacelle or of the blade.

FEATURES

Revolution ratios, ranging from 1:3 to 1:2870, result from the combination of different secondary output steps. Each cam can be set with great accuracy thanks to the cam adjusting screws. The auxiliary switches are of a positive opening type, thus suitable for safety functions.

OPTIONS

Fox can be fitted with different combinations of actuators and motion detectors: sets of cams and microswitches (max. 5), potentiometers or encoders (max. 1), absolute encoder Yankee 1 for set of cams and microswitches (max. 1).

It is possible to fit together sets of cams and microswitches, potentiometers, encoder and Yankee 1, thus creating a device featuring redundancy and diversity.

The limit switch is available with a flange for direct coupling to the motor. Different labels and colors are also available.

MATERIALS

Fox features transmission and gear driving shafts made of stainless steel AISI 430F or AISI 303, worm gear transmission shaft rotating on ball bearings, self-lubricating techno-polymer gears and driving bushes, techno-polymer base and cover. All techno-polymers used for the enclosure are wear resistant and protect the equipment against water and dust.



**INDUSTRIAL
LIFTING**



**CONSTRUCTION
LIFTING**



**INDUSTRIAL
AUTOMATION**



**STAGE
TECHNOLOGY**



**WIND
ENERGY**

STANDARDS - MARKINGS - HOMOLOGATIONS

- Conformity to Community Directives:
 - 2006/95/CE: Low Voltage Directive
 - 2006/42/CE: Machinery Directive
- Conformity to Standards:
 - EN 60204-1 Safety of machinery - Electrical equipment of machines
 - EN 60204-32 Safety of machinery - Electrical equipment of machines
 - Requirements for hoisting machines

- EN 60947-1 Low-voltage switchgear and controlgear
- EN 60947-5-1 Low-voltage switchgear and controlgear - Control circuit devices and switching elements - Electromechanical control circuit devices
- EN 60529 Degrees of protection provided by enclosures
- Regulations for the prevention of accidents BGV C 1 (only for Germany)
- CAN/CSA-C22.2 No 14-13 - Industrial Control Equipment
- UL 508 - Industrial Control Equipment

GENERAL TECHNICAL SPECIFICATIONS

- Storage ambient temperature: -40°C/+80°C
- Operational ambient temperature: -40°C/+80°C
- Protection degree:
 - IP 66 / IP 67 / IP 69K
- Insulation category: Class II
- Cable entry: cable clamp M20, M20+M16, M20+M20

- Rotation speed:
 - revolution ratios ≥1:16: max. 800 rev./min.
 - revolution ratios <1:16: max. 200 rev./min.
- HALT test (data available on request)
- Markings and homologations: SIL 1

TECHNICAL SPECIFICATIONS OF THE MICROSWITCHES

- Utilisation category:
 - AC 15 / 250 V / 3 A max.
 - DC 13 / 60 V / 0.5 A max.
- Rated thermal current: 10 A max.
- Rated insulation voltage: 300 Vac
- Mechanical life: 1.5x10⁶ operations max.
- Terminal referencing: according to EN 50013
- Connections: screw-type terminals
- Markings and homologations:
 - PRSL0100XX: (general purpose)
 - PRSL0110XX-PRSL0111XX:

- The snap action switch PRSL0100XX has 1 NO + 1 NC change over contacts.
 - The snap action switch PRSL0110XX has 1 NO + 1 NC change over contacts, double break.
 - The slow action switch PRSL0111XX has 1 NC contact, double break.
- All NC contacts are of the positive opening operation type . The switches have the following reference for internal wiring.

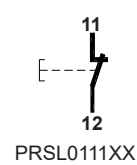
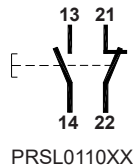
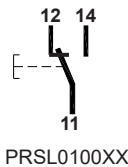

OVERALL DIMENSIONS (MM)

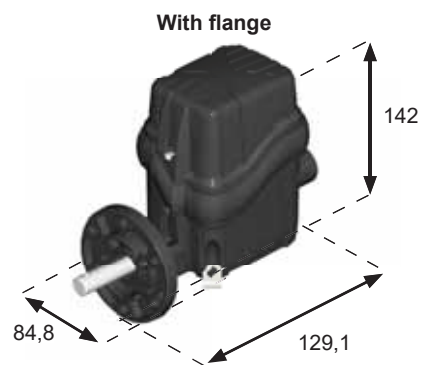
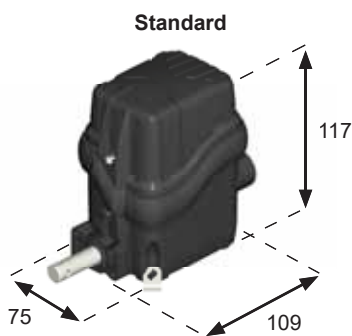

POSSIBLE ASSEMBLIES

With set of cams,
Yankee 1 absolute encoder



Yankee 1
absolute encoder



The data and the products illustrated in this brochure may be modified without notice. Under no circumstances can their description have a contractual value.







TER Tecno Elettrica Ravasi srl

Via Garibaldi 29/31 - 23885 Calco (LC) - Italy
Registered Office - via San Vigilio 2 - 23887 Olgiate Molgora (LC) - Italy
Tel. +39 0399911011 - Fax +39 0399910445 - E-mail: info@terworld.com

www.terworld.com

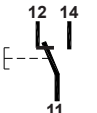
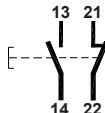
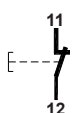
TECHNICAL SPECIFICATIONS OF THE MICROSWITCHES

Code	PRSL0100XX	PRSL0110XX	PRSL0111XX
Utilisation category	AC 15 DC13	AC 15	
Rated operational voltage	125 V / AC 15 230 V / AC 15 60 V / DC 13	250 V	
Rated operational current	2 A / 125 V / AC 15 1 A / 230 V / AC 15 0,5 A / 60 V / DC 13	3 A	
Rated thermal current	6 A	10 A	
Rated insulation voltage	250 V~	300 V~	
Mechanical life	1,5x10 ⁶ operations	1x10 ⁶ operations	
Terminal referencing	According to EN 50013	According to EN 50013	
Connections	screw-type terminals with self-lifting pads	screw-type terminals with self-lifting pads	
Wires	0,25 mm ² - 1,5 mm ²	1x2.5 mm ² , 2x1.5 mm ² (UL: copper conductor (CU) 60°C or 75°C with soft or stiff wire 14-16 AWG)	
Tightening torque	0,5 Nm - 0,6 Nm	0,5 Nm	
Switch type	Single break, snap action	Double break, snap action	Double break, slow action
Contacts	1NO + 1NC change over (All NC contacts are of the positive opening operation type )	1NO + 1NC change over (All NC contacts are of the positive opening operation type )	1NC (All NC contacts are of the positive opening operation type )
Scheme			
Markings and homologations	 (general purpose)		

TECHNICAL SPECIFICATIONS OF THE POTENTIOMETERS

Code with support	PA020001	PA020002
Ohmic value	10 kΩ	10 kΩ mechanical stop
Resolution	Infinite	
Independent linearity	± 1%	
Life time	10x10 ⁶ movements	
Operational ambient temperature	-55°C / +105°C	
Continuous rotation (without stop)	360°	
Continuous rotation (with stop)	333° ± 5°	
Actual electrical angle	310° ± 5°	
Ohmic value tolerance	± 20%	

Code with support	PA020003	PA020004	PA020005
Ohmic value	10 kΩ	10 kΩ	5 kΩ
Connections	4 turrets	3 turrets	4 turrets
Independent linearity (over AEA -3°)	≤ ± 1 %	≤ ± 0,35 %	≤ ± 1 %
Life time	5x10 ⁶ movements		
Operational ambient temperature	-55°C / +125°C		
Mechanical angle	360° continuous		
Actual Electrical Angle (AEA)	340° ± 5°		
Ohmic value tolerance	max ± 20 % at 20°C	max ± 10 % at 20°C	max ± 20 % at 20°C

TECHNICAL SPECIFICATIONS OF THE ENCODERS

Code with support	PA030001	PA030002
Resolution	36 pulses/rev.	150 pulses/rev.
Operational ambient temperature	-40°C / +85°C	
Code	Incremental	
Supply voltage	4,5 Vdc min. to 30 Vdc max. (35 mA max. - no load)	
Output voltage	Low: 500 mV max. at 10 mA High: (Vin - 0,6) at -10 mA (Vin - 1,3) at -25 mA	
Output current	25 mA max. load per output channel	
Output format	Two channel (A, B) quadrature with Index (Z)	
Phase sense	A leads B clockwise (CW) from the mounting end of the encoder	
Accuracy	+/- 0,8 arc-min.	
Outputs	Push pull	
Electrical protection	Reverse polarity and output short circuit protected	

TECHNICAL SPECIFICATIONS OF THE ABSOLUTE ENCODER YANKEE 1

Code	PA01AA01	PA01AB01	PA01AC01
Analog Output	Current 4+20mA	Voltage 0+10V	PWM 0+100%
Operational ambient temperature	-40°C / +80°C		
Power supply	12 ÷ 48 VDC / 12 ÷ 48 Vac		
Protection against polarity inversion	yes		
Absorption	50 mA		
Resolution	12 bit		
Linearity	+/- 0,5°		
Max. hysteresis	0,1°		
Setting Zero Point	through button/wire		
Signal increment direction	CW (standard) / CCW (on request)		
Connections	terminal board		

The data and the products illustrated in this brochure may be modified without notice. Under no circumstances can their description have a contractual value.



TER Tecno Elettrica Ravasi srl

Via Garibaldi 29/31 - 23885 Calco (LC) - Italy

Registered Office - via San Vigilio 2 - 23887 Olgiate Molgora (LC) - Italy

Tel. +39 0399911011 - Fax +39 0399910445 - E-mail: info@terworld.com

www.terworld.com

OVERALL DIMENSIONS (MM)

STANDARD

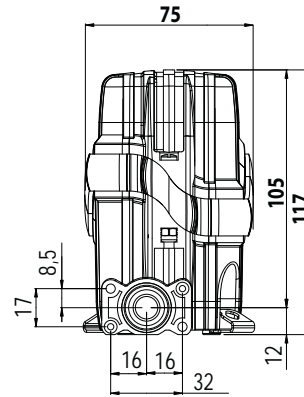
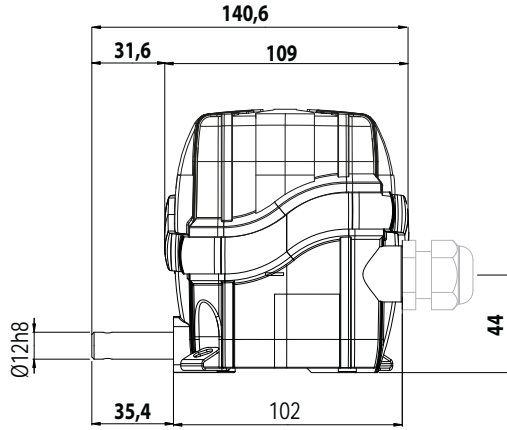
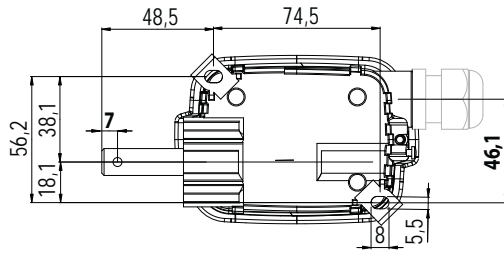

WITH FLANGE

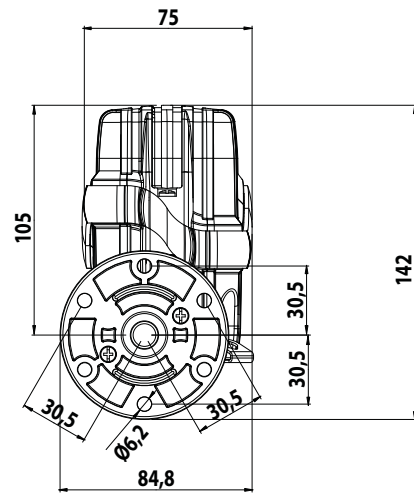
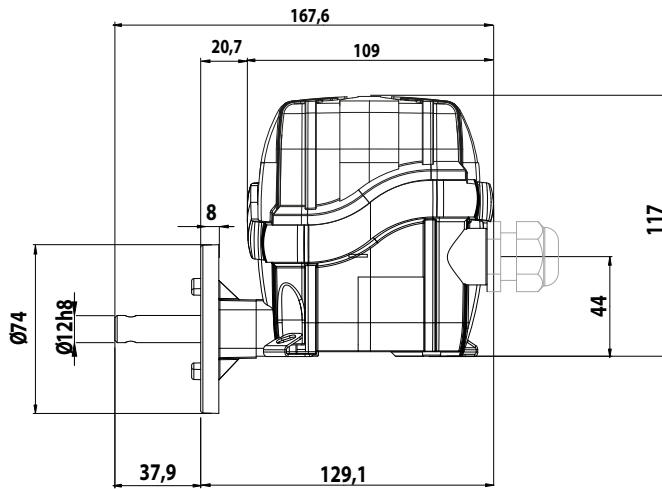
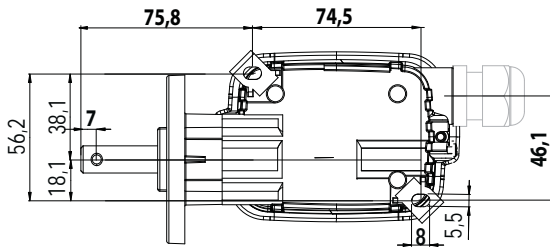

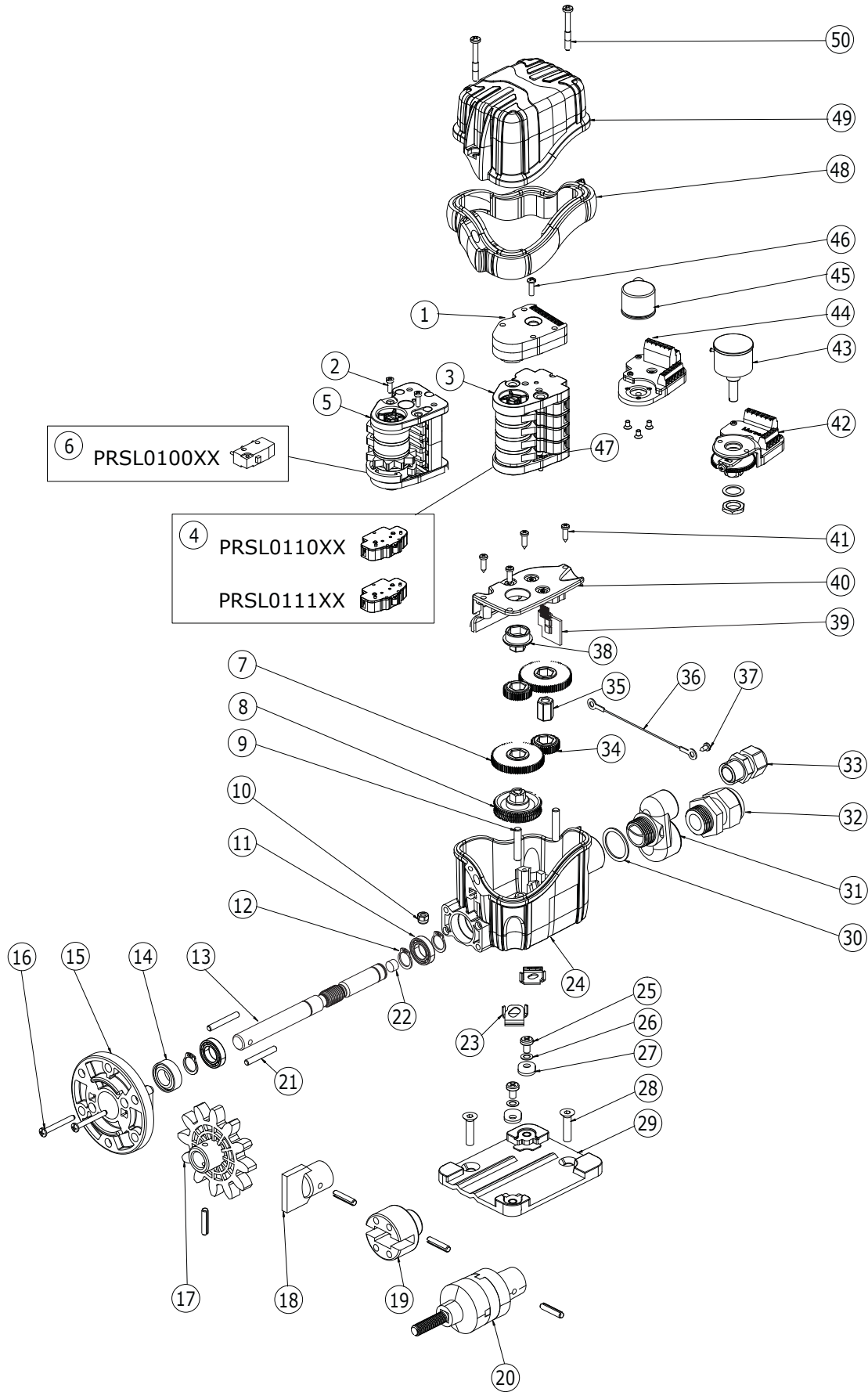

The data and the products illustrated in this brochure may be modified without notice. Under no circumstances can their description have a contractual value.



TER Tecno Elettrica Ravasi srl

Via Garibaldi 29/31 - 23885 Calco (LC) - Italy
 Registered Office - via San Vigilio 2 - 23887 Olgiate Molgora (LC) - Italy
 Tel. +39 0399911011 - Fax +39 0399910445 - E-mail: info@terworld.com

www.terworld.com

COMPONENTS







SWITCHES

REF.	DRAWING	DESCRIPTION	SCHEME	CODE
4		1NO+1NC switch double break, snap action		PRSL0110XX
		1NC switch double break, slow action		PRSL0111XX
6		1NO+1NC switch single break, snap action		PRSL0100XX





STANDARD CAM SETS

REF.	DRAWING	NO. AND TYPE OF CAMS	NO. AND TYPE OF SWITCH	SET CODE	
3		2 cams D	2 PRSL0110XX switches	FCL20001	
		2 cams D	2 PRSL0111XX switches	FCL20002	
		Cams D+E	2 PRSL0110XX switches	FCL20003	
		Cams D+E	2 PRSL0111XX switches	FCL20004	
		2 cams E	2 PRSL0110XX switches	FCL20005	
		2 cams E	2 PRSL0111XX switches	FCL20006	
	3		3 cams D	3 PRSL0110XX switches	FCL30001
			3 cams D	3 PRSL0111XX switches	FCL30003
			3 cams E	3 PRSL0110XX switches	FCL30002
			3 cams E	3 PRSL0111XX switches	FCL30004
			Cams F + F + C + B	4 PRSL0110XX switches	FCL40001
			Cams F + F + C + B	4 PRSL0111XX switches	FCL40002
4 cams D			4 PRSL0110XX switches	FCL40003	
4 cams D			4 PRSL0111XX switches	FCL40004	
Cams D + D + E + E			4 PRSL0110XX switches	FCL40005	
Cams D + D + E + E			4 PRSL0111XX switches	FCL40006	
4 cams E			4 PRSL0110XX switches	FCL40007	
4 cams E			4 PRSL0111XX switches	FCL40008	
5		2 cams D	2 PRSL0100XX switches	FCN20001	
		Cams D+E	2 PRSL0100XX switches	FCN20002	
		2 cams E	2 PRSL0100XX switches	FCN20003	
		Cams F + F + C + B	4 PRSL0100XX switches	FCN40001	
		4 cams D	4 PRSL0100XX switches	FCN40002	
		Cams D + D + E + E	4 PRSL0100XX switches	FCN40003	
		4 cams E	4 PRSL0100XX switches	FCN40004	
		Cams E + E + E + A	4 PRSL0100XX switches	FCN40005	
		Cams D + D + A + A	4 PRSL0100XX switches	FCN40006	

Other sets with 2-3-4 or 5 cams/switches available on request.
PRSL0100XX only for 2 or 4 cam sets.

CAM REFERENCE CHART									
CAM	MECHANICAL ANGLE	CODE FOR PRSL0110XX PRSL0111XX SWITCHES	CODE FOR PRSL0100XX SWITCHES	CAM	MECHANICAL ANGLE	CODE FOR PRSL0110XX PRSL0111XX SWITCHES	CODE FOR PRSL0100XX SWITCHES		
A		180°	PRSL7191PI	PRSL7121PI	D		-	PRSL7194PI	PRSL7124PI
B		320°	PRSL7192PI	PRSL7122PI	E		60°	PRSL7195PI	PRSL7125PI
C		-	PRSL7193PI	PRSL7123PI	F		72°	PRSL7196PI	PRSL7126PI

SENSORS, POTENTIOMETERS AND ENCODERS

REF.	DRAWING	DESCRIPTION	CODE
1		Yankee 1 - current output	PA01AA01
		Yankee 1 - voltage output	PA01AB01
		Yankee 1 - PWM output	PA01AC01
43+42		Potentiometer MCB 10 kΩ with support	PA020001
		Potentiometer MCB 10 kΩ mechanical stop with support	PA020002
		Potentiometer Sfernice 10 kΩ ±10% 4 pins with support	PA020003
		Potentiometer Sfernice 10 kΩ ±10% 3 pins with support	PA020004
42		Potentiometer Sfernice 5 kΩ ±10% with support	PA020005
		Support for potentiometer	PA020000
45+44		Encoder 36 pulses./rev. with support	PA030001
		Encoder 150 pulses./rev. with support	PA030002
44		Support for encoder	PA030000

PINION GEARS

REF.	DRAWING	DESCRIPTION	CODE
17		Pinion gear M10 Z12 with pin	PRSL0911PI
		Pinion gear M12 Z10 with pin	PRSL0912PI
		Pinion gear M14 Z10 with pin	PRSL0913PI
		Pinion gear M16 Z10 with pin	PRSL0914PI
		Pinion gear M20 Z8 with pin	PRSL0915PI
		Pinion gear M5 Z12 with pin	PRSL0916PI
		Pinion gear M6 Z11 with pin	PRSL0917PI
		Pinion gear M8 Z12 with pin	PRSL0918PI
		Pinion gear M12 Z12 with pin	PRSL0944PI

Other pinion gears available: see "Gears and pinion gears" catalog

The data and the products illustrated in this brochure may be modified without notice. Under no circumstances can their description have a contractual value.



TER Tecno Elettrica Ravasi srl







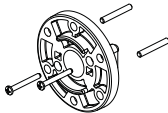

Via Garibaldi 29/31 - 23885 Calco (LC) - Italy

Registered Office - via San Vigilio 2 - 23887 Olgiate Molgora (LC) - Italy

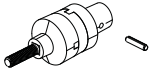
Tel. +39 0399911011 - Fax +39 0399910445 - E-mail: info@terworld.com

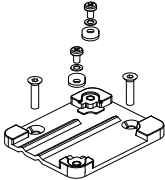
www.terworld.com

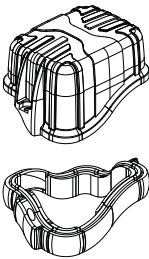

ACCESSORIES

REF.	DRAWING	DESCRIPTION	CODE
15+16+21		Flange with screws and pins	PRSL0356PI
18		Male coupling with pin	PRSL0919PI
19		Female coupling with pin	PRSL0920PI
20		Coupling with pin	PRSL0981PI
23		Feet	PRTR0150PE
25+26+27 +28+29		Fixing plate	PRSL0425PI
32		Cable clamp M20	PRPS0064PE
33		Cable clamp M16	PRPS0062PE
36		Cover holding wire	PRVV9140PE
49+48		Cover with tightening rubber	PA090005

REMARKS

STANDARD LIMIT SWITCHES

All standard limit switches are equipped with cams PRSL7194PI  for PRSL0110XX and PRSL0111XX switches, PRSL7124PI  for PRSL0100XX switches and shafts made of stainless steel AISI 430F.

RATED REVOLUTION RATIO	REAL REVOLUTION RATIO	NUMBER OF CAMs AND SWITCHES	SWITCHES		
			PRSL0100XX	PRSL0110XX	PRSL0111XX
			 1 NO + 1 NC	 1 NO + 1 NC	 1 NC
			CODE	CODE	CODE
1 : 15	1 : 16	2	PFB9067A0016002	PFB9067L0016010	PFB9067L0016012
		3	-	PFB9067L0016011	PFB9067L0016013
		4	PFB9067A0016003	PFB9067L0016008	PFB9067L0016014
1 : 20	1 : 20,21	2	PFB9067A0020001	PFB9067L0020006	PFB9067L0020008
		3	-	PFB9067L0020007	PFB9067L0020009
		4	PFB9067A0020002	PFB9067L0020004	PFB9067L0020010
1 : 25	1 : 27,27	2	PFB9067A0027007	PFB9067L0027007	PFB9067L0027017
		3	-	PFB9067L0027016	PFB9067L0027018
		4	PFB9067A0027008	PFB9067L0027014	PFB9067L0027019
1 : 50	1 : 62	2	PFB9067A0062006	PFB9067L0062033	PFB9067L0062045
		3	-	PFB9067L0062044	PFB9067L0062046
		4	PFB9067A0062009	PFB9067L0062003	PFB9067L0062025
1 : 75	1 : 75,48	2	PFB9067A0075005	PFB9067L0075008	PFB9067L0075010
		3	-	PFB9067L0075009	PFB9067L0075004
		4	PFB9067A0075006	PFB9067L0075006	PFB9067L0075011
1 : 100	1 : 103,44	2	PFB9067A0103009	PFB9067L0103037	PFB9067L0103038
		3	-	PFB9067L0103049	PFB9067L0103027
		4	PFB9067A0103008	PFB9067L0103030	PFB9067L0103050
1 : 150	1 : 162,52	2	PFB9067A0162006	PFB9067L0162007	PFB9067L0162008
		3	-	PFB9067L0162006	PFB9067L0162009
		4	PFB9067A0162007	PFB9067L0162003	PFB9067L0162002
1 : 200	1 : 222,58	2	PFB9067A0222005	PFB9067L0222011	PFB9067L0222014
		3	-	PFB9067L0222013	PFB9067L0222015
		4	PFB9067A0222001	PFB9067L0222010	PFB9067L0222016
1 : 250	1 : 254,57	2	PFB9067A0254003	PFB9067L0254019	PFB9067L0254010
		3	-	PFB9067L0254020	PFB9067L0254021
		4	PFB9067A0254004	PFB9067L0254008	PFB9067L0254022

The data and the products illustrated in this brochure may be modified without notice. Under no circumstances can their description have a contractual value.



TER Tecno Elettrica Ravasi srl

Via Garibaldi 29/31 - 23885 Calco (LC) - Italy

Registered Office - via San Vigilio 2 - 23887 Olgiate Molgora (LC) - Italy

Tel. +39 0399911011 - Fax +39 0399910445 - E-mail: info@terworld.com

www.terworld.com

Cam set

Standard cam set*

Customised cam set*

<input type="checkbox"/>	<input type="checkbox"/>
<input type="checkbox"/>	<input type="checkbox"/>
<input type="checkbox"/>	<input type="checkbox"/>
<input type="checkbox"/>	<input type="checkbox"/>
<input type="checkbox"/>	<input type="checkbox"/>

CAMS SWITCHES

* Mark the number corresponding to the cam set required, if standard; otherwise mark the letters corresponding to the single cams and switches required.
PRSL0100XX only for 2 or 4 cam sets.

Standard cam sets

Switches

Cams

 D D

 D E

 E E

 D D D

 E E E

 F F C B

 D D D D

 D D E E

 E E E E

 E E E A

 D D A A

PRSL0100XX

 1

 2

 3

 -

 -

 4

 5

 6

 7

 8

 9

PRSL0110XX

 10

 11

 12

 13

 14

 15

 16

 17

 18

 19

 20

PRSL0111XX

 21

 22

 23

 24

 25

 26

 27

 28

 29

 30

 31

Remarks

Cams



(Degrees correspond to mechanical angle)

Switches

 X PRSL0100XX

 Y PRSL0110XX

 Z PRSL0111XX

Potentiometer

 PA020001

 PA020002

 PA020003

 PA020004

 PA020005

Encoder

 PA030001

 PA030002

Yankee 1 *

 PA01AA01

 PA01AB01

 PA01AC01

* Programmable

ATTENTION: it is possible to mount 1 potentiometer, 1 encoder or 1 absolute encoder Yankee 1 alone or together with a set of cams.

Yankee 1 can be mounted only with sets of 2, 3 or 4 cams.

Potentiometers PA020001 and PA020002 can be mounted only with sets of 2 cams. Any other standard potentiometer and encoder can be mounted with sets of 2 or 3 cams.

Codes for PRSL0110XX PRSL0111XX switches

PRSL7191PI

PRSL7192PI

PRSL7193PI

PRSL7194PI

PRSL7195PI

PRSL7196PI

Codes for PRSL0100XX switches

PRSL7121PI

PRSL7122PI

PRSL7123PI

PRSL7124PI

PRSL7125PI

PRSL7126PI

Shaft

 Shaft made of stainless steel AISI 430F

 Shaft made of high resistance stainless steel AISI 303

Revolution ratio

 1:15

 1:150

 1:20

 1:200

 1:25

 1:250

 1:50

 1:300

 1:75

 1:450

 1:100

 1:

Male coupling



Female coupling



Coupling

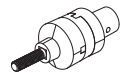

Flange



Pinion gear

 PRSL0911PI

M10 Z12

 PRSL0912PI

M12 Z10

 PRSL0913PI

M14 Z10

 PRSL0914PI

M16 Z10

 PRSL0915PI

M20 Z8

 PRSL0916PI

M5 Z12

 PRSL0917PI

M6 Z11

 PRSL0918PI

M8 Z12

 PRSL0944PI

M12 Z12

 Customised

M Z

Cable clamp

 M20

 M20 + M16

 M20 + M20

 SIL1 Version

USE AND MAINTENANCE INSTRUCTIONS

Fox rotary limit switch is an electromechanical device for low voltage control circuits (EN 60947-1, EN 60947-5-1) to be used as electrical equipment on machines (EN 60204-1) in compliance with the fundamental requirements of the Low Voltage Directive 2006/95/CE and of the Machine Directive 2006/42/CE.

The limit switch is designed for use in industrial environments under even severe climatic conditions (operational temperature from -40°C to $+80^{\circ}\text{C}$, suitable for use in tropical environment). The equipment is not suitable for use in environments with potentially explosive atmosphere, corrosive agents or a high percentage of sodium chloride (saline fog). Oils, acids or solvents may damage the equipment; avoid using them for cleaning. Do not connect more than one phase to each switch. Do not oil or grease the control elements or the switches.

The limit switch is supplied with a bag of accessories including: 2 fixing feet (9), 2 self-locking nuts (7), 2 metric screws (1), 1 no-drop wire (2), 1 self-tapping screw (3),

1 cable clamp (4). Furthermore, accessories may include, in addition to the above-mentioned parts and instead of the cable clamp (4), 1 double cable clamp holder (14), 2 cable clamps M20 (15) or 1 cable clamp M20 (15) and 1 cable clamp M16 (16).

The installation of the limit switch shall be carried out by expert and trained personnel. Wiring shall be properly done according to the current instructions.

Prior to the installation and the maintenance of the limit switch, the main power of the machinery shall be turned off.

Steps for the proper installation of the limit switch

- place the self-locking nuts (7) in their seats in the enclosure (6)
- insert one end of the no-drop wire (2) into the self-tapping screw (3) and tighten the screw into its hole on the enclosure (6)
- insert the fixing feet (9) into their seats in the lower part of the enclosure (6)
- connect the limit switch shaft (08) and the reduction gear shaft avoiding any misalignment between the two shafts
- fix the limit switch tight in order to avoid vibrations of the equipment during operation; for fixing operations use only the feet (9) with metric screws M4 or M5 and their washers
- in case a single multicore cable is employed, screw the cable clamp (4) to the enclosure (6); when two multicore cables are employed, use the cable clamp holder (14), then screw cable clamps (15, 16) to the cable clamp holder
- insert the cable into the limit switch through the cable clamp (4, 15, 16)
- strip the multipole cable to a length suitable for stripping the single poles; we suggest the use of pin terminals
- clamp the wire into the cable clamp (4, 15, 16)
- when PRSL0110XX and PRSL0111XX switches are used connect the switches according to the contact scheme printed on the switches or to the wiring scheme on the back of the instructions (tighten the wires into the terminals with a torque equal to 0.5 Nm; (UL (c)UL: use 60°C or 75°C copper (CU) conductors and stiff or flexible wire 14-16 AWG); insertability of wires into the terminals $2 \times 0.5 \text{ mm}^2$ $2 \times 1.5 \text{ mm}^2$ $1 \times 2.5 \text{ mm}^2$)
- when PRSL0100XX switches are used connect the terminals according to the contact scheme printed on the label placed on the cam set (tighten the wires to the terminals with a torque of 50/60 cNm; insertability of wires into the terminals $0.25/1.5 \text{ mm}^2$)
- adjust the operating point of the cams; for proper adjustment, loosen the central screw (12) of the cam set, adjust the operating point of each single cam by turning its adjusting screw (11) (the numbers on the screws refer to the cams counting from bottom to top of the set), then tighten the central screw (12)
- insert the free end of the no-drop wire (2) into one of the metric screws (1), then tighten the metric screws (1) to close the limit switch; check the proper positioning of the rubber in the cover (5) and tighten the screws (1) with a torque of 80/100 cNm

Steps for routine maintenance

- check the proper tightening of the screws (1) of the cover (5)
- check the proper tightening of the switch terminal screws
- check the proper tightening of the central screw (12) holding the cams (11)
- check the wiring conditions (in particular where wires clamp into the terminals)
- if there is an anti-moisture plug, check its conditions
- check the conditions of the rubber fit into the cover (5) and check the tightening of the cable clamp (4, 15, 16) around the cable
- check that the limit switch enclosure (5, 6) is not broken
- check the alignment between the limit switch shaft (8) and the reduction gear shaft
- check that the limit switch is properly fixed

Any change to parts of the limit switch will invalidate the rating plate and identification data of the device, and render the warranty null and void. In case of replacement of any part, use original spare parts only.

TER declines all responsibility for damages caused by the improper use or installation of the equipment.

Technical Specifications UL with PRSL0110XX and PRSL0111XX switches

Code Fox certified UL = PFB9U67L XXXX XXX
= PFB9U67M XXXX XXX

Contact Blocks Rating = A600, Q600

Environmental Rating = Type 1

Cord diameter range = 0.51 in (13mm)

Cord type = flexible, type minimum S or SJ (ZJCZ/7)

Wire size range = 14-16 AWG stranded or solid

Conductors = Copper (CU) 60/75°C

Terminal tightening torque = 4.50 lb.in (0.5Nm)

Marking = 

The data and the products illustrated in this brochure may be modified without notice. Under no circumstances can their description have a contractual value.



TER Tecno Elettrica Ravasi srl

Via Garibaldi 29/31 - 23885 Calco (LC) - Italy

Registered Office - via San Vigilio 2 - 23887 Olgiate Molgora (LC) - Italy

Tel. +39 0399911011 - Fax +39 0399910445 - E-mail: info@terworld.com

www.terworld.com

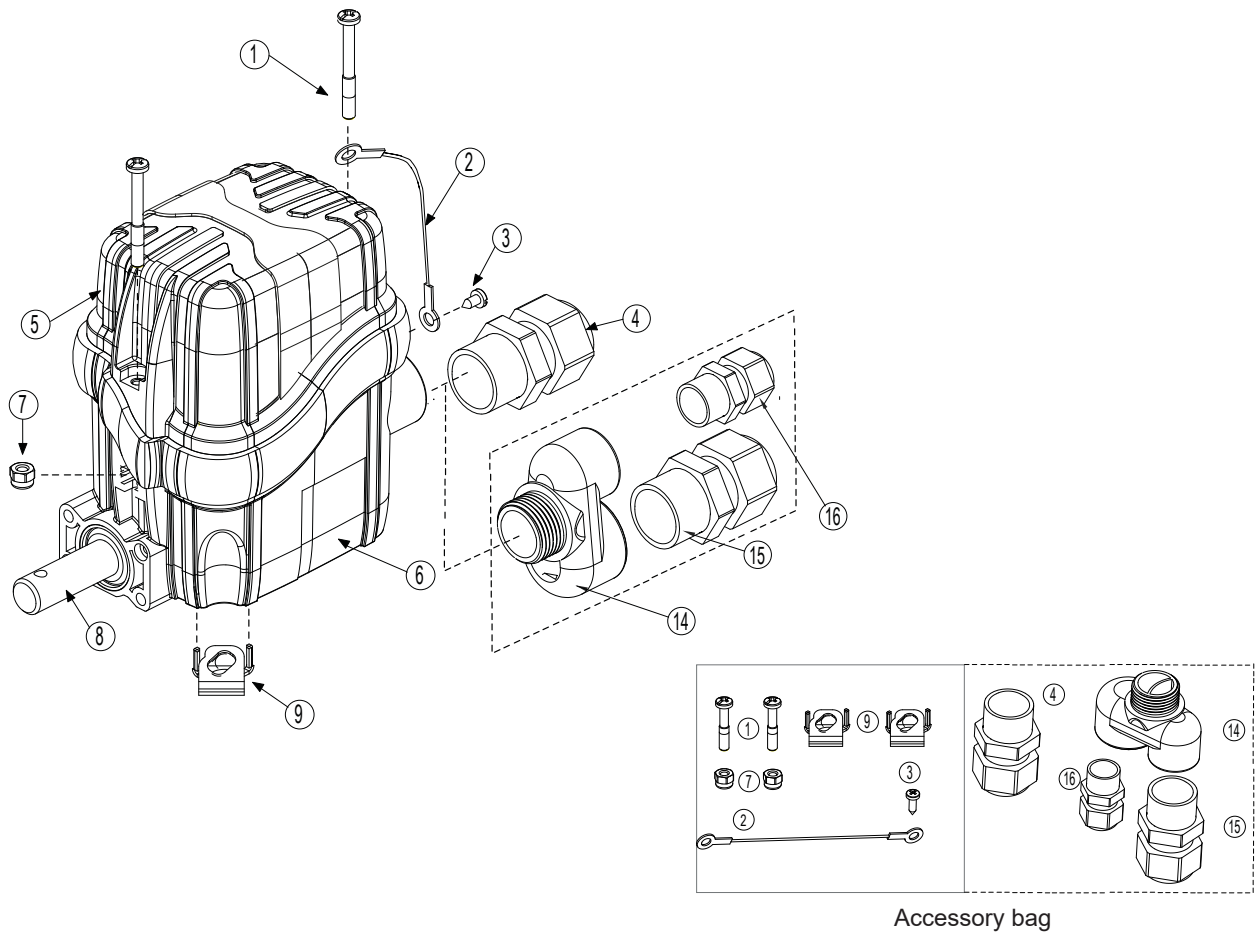

Accessory bag

Cam set with PRSL0110XX or PRSL0111XX switches

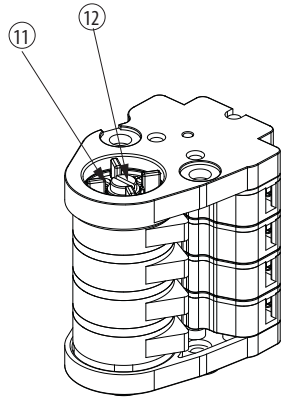

Cam set with PRSL0100XX switches

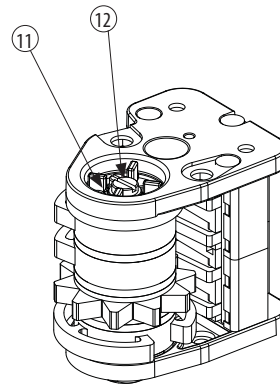

*Image for illustrative purpose
the number and type of cams is different according to the model*

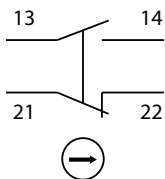

Wiring Layout Switches
PRSL0110XX

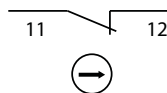

Wiring Layout Switches
PRSL0111XX

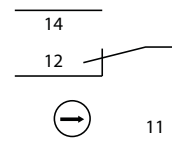

Wiring Layout Switches
PRSL0100XX

