



# VICTOR

## WALL-MOUNTED CONTROL STATION

Victor is a wall-mounted control station used for the control of industrial machines. This auxiliary control acts on the motor of the machine through a power interface, such as a contactor or relay or through PLC logic.

### DESIGN

Victor has an innovative design, where each graphic element is linked to a specific technical function. Its dimensions and shape are the result of careful analysis of the product ergonomic aspects, aimed at achieving a graphic style that blends in with modern industrial environments, making Victor user friendly and easy to integrate in the machine. Its compact dimensions and antislip grooves on the case make it easy to handle under any working conditions.

### FEATURES

Victor has been designed to facilitate wiring and maintenance: the switches are installed in the base of the control station, together with the inlet of the cable, and are separated from the actuators, installed on the cover; this drastically reduces time and costs for installation and maintenance down time. The emergency stop mushroom pushbutton complies with ISO13850 regulation and is equipped with positive opening NC switches.

### OPTIONS

Victor is available in configurations with 1 to 8 actuators, with 1NO or 1NC switches, LED voltage 24/48 V AC/DC or 110/230 V AC, and potentiometers.

The range includes actuators in various colours: one or two speed buttons, selector switches and key-operated switches in various actuation configurations, pilot lights, pulsed or latched mushroom pushbuttons with rotation or key-operated release. One-speed pushbuttons and selector switches are available in illuminated version in a range of colours.

Victor cable clamp can be installed at the top, at the bottom or on the rear panel of the control station. Victor is available also with magnetic mounting case.

Label sheets (symbols and lettering) are available to be applied to the upper cover near the actuators, according to customers' needs. Upon request Victor can be supplied with pushbuttons bearing two-colour moulded symbols, making the symbols permanent.

### MATERIALS

The 22.5 mm rubber pushbuttons ensure protection against dust penetration, to prevent them from becoming stuck when the control station is used in particularly harsh conditions.

All the materials and components used are weather resistant and guarantee protection of the unit against the penetration of water and dust.



**INDUSTRIAL  
LIFTING**



**CONSTRUCTION  
LIFTING**



**INDUSTRIAL  
AUTOMATION**



**STAGE  
TECHNOLOGY**

## STANDARDS - MARKINGS - HOMOLOGATIONS

- Conformity to Community Directives:
  - 2006/95/CE: Low Voltage Directive
  - 2006/42/CE: Machinery Directive
- Conformity to Standards:
  - EN 60204-1 Safety of machinery - Electrical equipment of machines
  - EN 60947-1 Low-voltage switchgear and controlgear
  - EN 60947-5-1 Low-voltage switchgear and controlgear - Control circuit devices and switching elements - Electromechanical control circuit devices

- EN 60947-5-5 Low-voltage switchgear and controlgear - Control circuit devices and switching elements - Electrical emergency stop device with mechanical latching function
- EN 60529 Degrees of protection provided by enclosures
- ISO13850 Safety of machinery - Emergency stop - Principles for design
- CSA-C22.2 No 14-13 - Industrial Control Equipment
- UL 508 - Industrial Control Equipment

## GENERAL TECHNICAL SPECIFICATIONS

- Storage ambient temperature: -40°C/+80°C
- Operational ambient temperature: -40°C/+80°C
- Protection degree: IP 66 / IP 67 / IP 69K
- Insulation category: Class II
- Cable entry: cable clamp M20 x 1.5
- Operating positions: any position
- Mechanical life
  - 1 speed pushbutton: 10x10<sup>6</sup> operations
  - 2 speed pushbutton: 10x10<sup>6</sup> operations
  - illuminated pushbutton: 10x10<sup>6</sup> operations
- HALT test (data available on request)
- Markings and homologations: **CE** **cULus** **ERC** **SIL 1**
- UL Environmental Rating: (Victor grey and black) Type 1, 4 and 4X (Victor yellow) Type 1, 4 and 4X indoor use only

## TECHNICAL SPECIFICATIONS OF THE MICROSWITCHES

- Utilisation category: AC 15
- Rated operational current: 3 A
- Rated operational voltage: 250 Vac
- Rated thermal current: 10 A
- Rated insulation voltage: 300 Vac
- Mechanical life: 10x10<sup>6</sup> operations
- Terminal referencing: according to EN 50013
- Connections: screw-type terminals
- Wires: 2x0,5mm<sup>2</sup> - 2x1,5 mm<sup>2</sup> - 1x2,5 mm<sup>2</sup>
- Tightening torque: 0.5 Nm
- Markings and homologations: **CE** **UL** **SE**

The slow action switch PRSL1800PI has 1 NO contact, double break.  
 The slow action switch PRSL1801PI has 1 NC, double break.  
 All NC contacts are of the positive opening operation type .  
 The switches have the following reference for internal wiring.

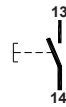

PRSL1800PI

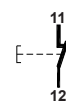

PRSL1801PI

## TECHNICAL SPECIFICATIONS OF THE LEDs

- Electrical ratings PRSL1821PI: 110-240 Vac, 1.15-2.50 mA
- Electrical ratings PRSL1820PI: 24-48 Vac/dc, 1.30-2.70 mA
- Markings and homologations: **CE** **cULus**



PRSL1820PI / PRSL1821PI

## OVERALL DIMENSIONS (MM)

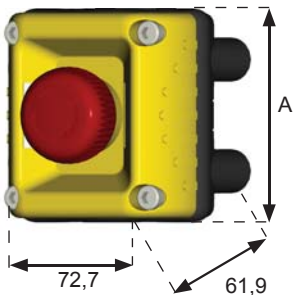

N° of buttons	Length (mm)
	A
1	72,9
2	122
3	152
4	182
6	242
8	302

The data and the products illustrated in this brochure may be modified without notice. Under no circumstances can their description have a contractual value.





**TER Tecno Elettrica Ravasi srl**

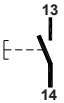
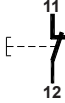

Via Garibaldi 29/31 - 23885 Calco (LC) - Italy  
 Registered Office - via San Vigilio 2 - 23887 Olgiate Molgora (LC) - Italy  
 Tel. +39 0399911011 - Fax +39 0399910445 - E-mail: info@terworld.com

**www.terworld.com**

## TECHNICAL SPECIFICATIONS OF THE MICROSWITCHES

Code	PRSL1800PI	PRSL1801PI
Utilisation category	AC 15	
Rated operational voltage	250 V	
Rated operational current	3 A	
Rated thermal current	10 A	
Rated insulation voltage	300 Vac	
Mechanical life	10x10 <sup>6</sup> operations	
Terminal referencing	According to EN 50013	
Connections	screw-type terminals	
Wires	2x0.5mm <sup>2</sup> - 2x1.5 mm <sup>2</sup> - 1x2.5 mm <sup>2</sup>	
Tightening torque	0.5 Nm	
Switch type	Double break, slow action	Double break, slow action
Contacts	1NO	1NC (All NC contacts are of the positive opening operation type  )
Scheme		
Markings and homologations	CE  	

## TECHNICAL SPECIFICATIONS OF THE LEDs

Code	PRSL1820PI	PRSL1821PI
Rated operational voltage	110-240 Vac	24-48 Vac/dc
Rated absorbed current	1.15-2.50 mA	1.30-2.70 mA
Scheme		
Markings and homologations	CE 	

## TECHNICAL SPECIFICATIONS OF THE POTENTIOMETERS

Code	PRVV9079PE	PRVV9019PE	PRVV9039PE
Ohmic value	1 kΩ	4.7 kΩ	10 kΩ
Life time	15000 movements (minimum)		
Operational ambient temperature	-25°C / +70°C		
Mechanical angle	300°		
Actual electrical angle	267°		
Ohmic value tolerance	± 20%		

**OVERALL DIMENSIONS (MM)**

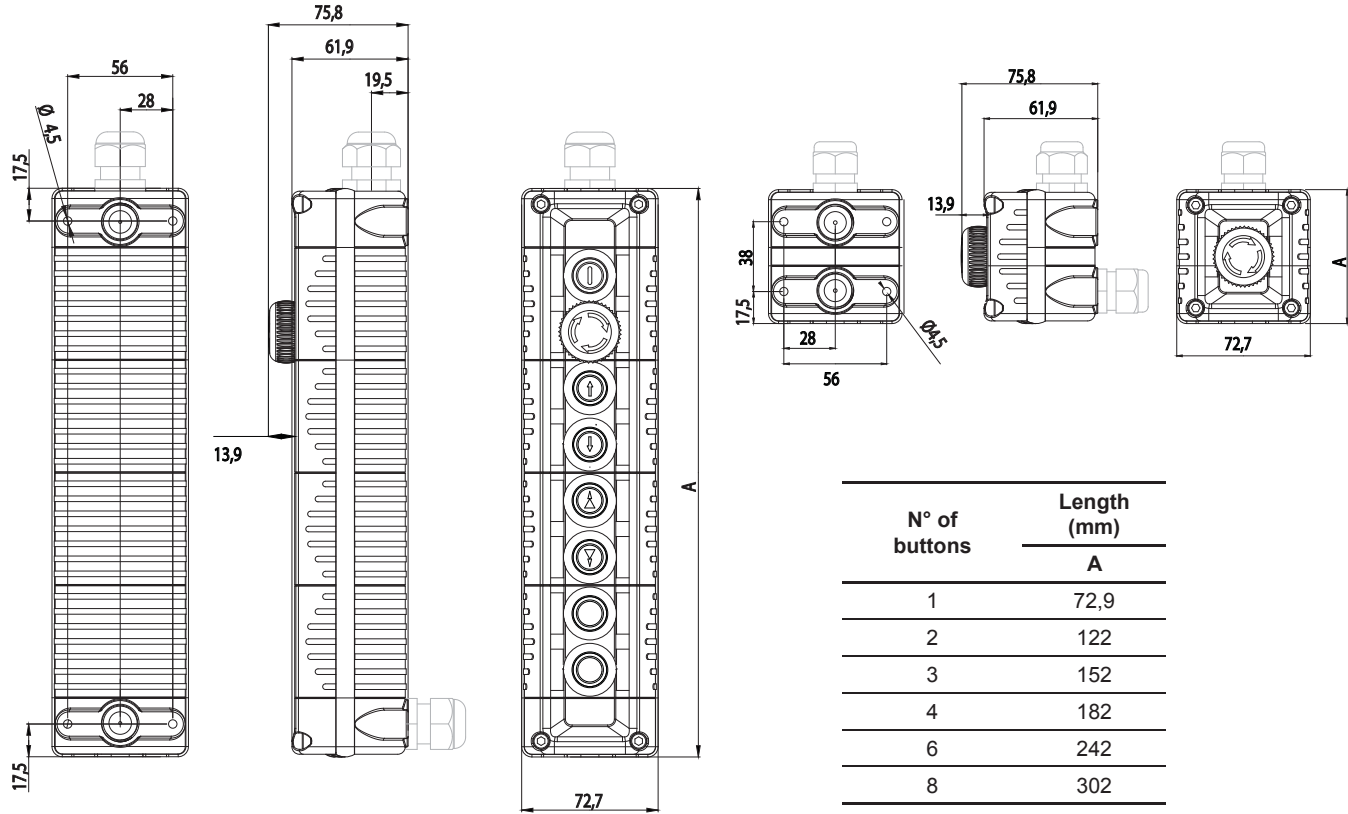

**ACTUATORS**

Key selector switches

Selector switches

Key mushroom pushbutton

Mushroom pushbutton Ø 40 mm

Potentiometer

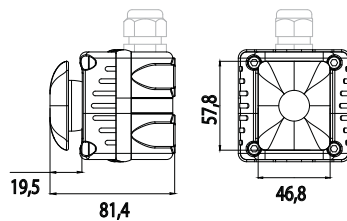
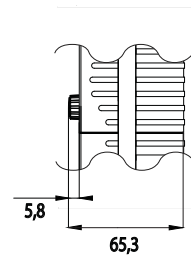
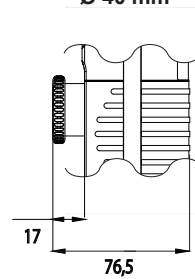
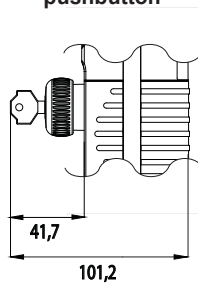
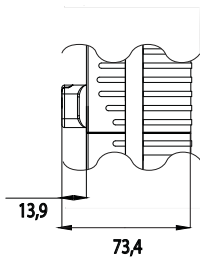
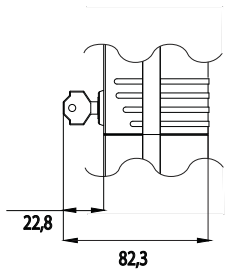

Rectangular Mushroom pushbutton  
(available only for Victor with 1 buttons)

Dimensions of all mushroom pushbuttons are in released position

The data and the products illustrated in this brochure may be modified without notice. Under no circumstances can their description have a contractual value.



**TER Tecno Elettrica Ravasi srl**



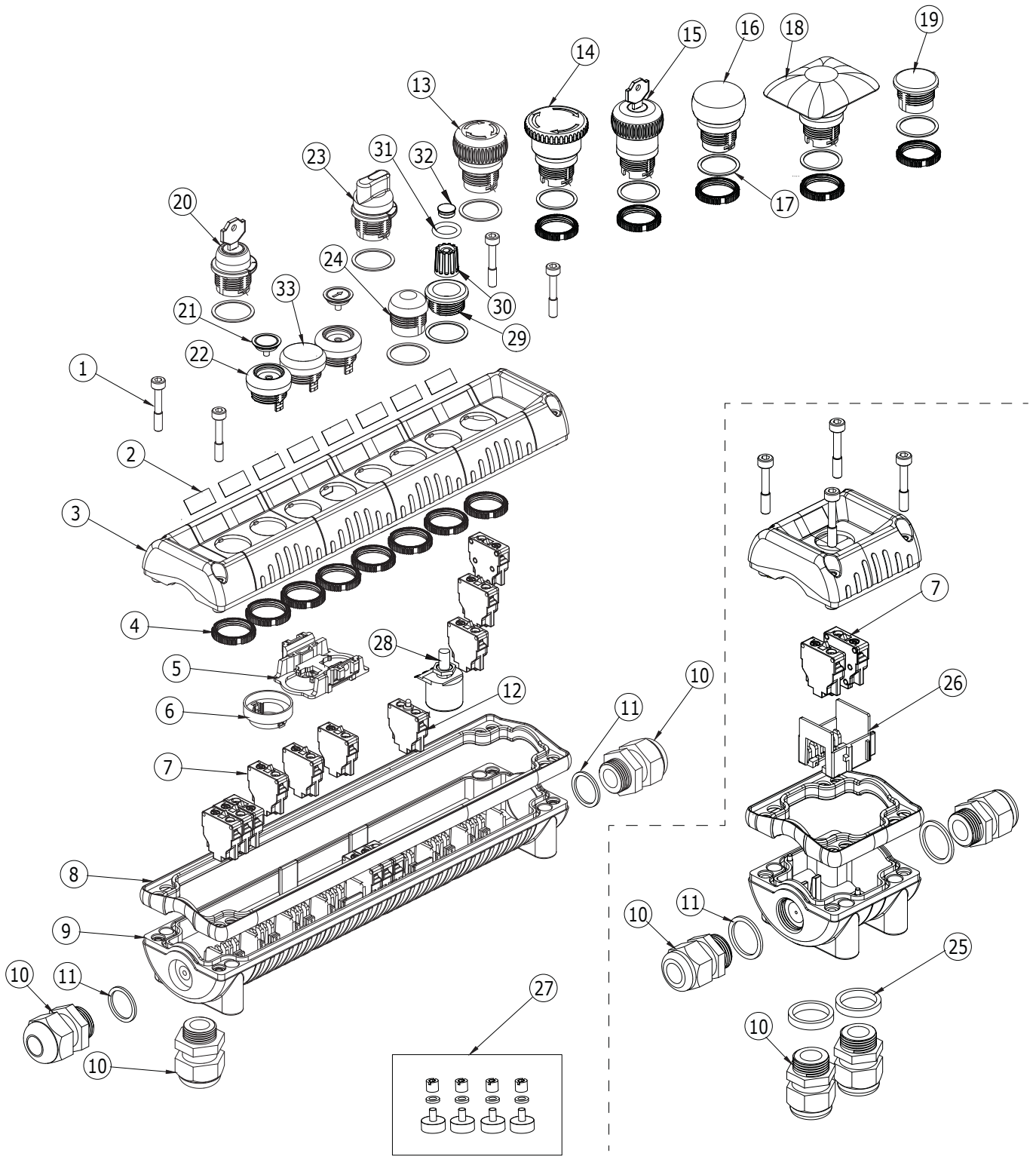

Via Garibaldi 29/31 - 23885 Calco (LC) - Italy  
Registered Office - via San Vigilio 2 - 23887 Olgiate Molgora (LC) - Italy  
Tel. +39 0399911011 - Fax +39 0399910445 - E-mail: info@terworld.com

[www.terworld.com](http://www.terworld.com)



## COMPONENTS





### SWITCHES

REF	DRAWING	DESCRIPTION	SCHEME	CODE
7		1NO single switch		PRSL1800PI
		1NC single switch		PRSL1801PI
12		LED element 24/48 V AC/DC	-	PRSL1820PI
		LED element 110/230 V AC	-	PRSL1821PI

### POTENTIOMETERS

REF	DRAWING	DESCRIPTION	CODE
32+31+30+29+17+4+28		Potenziometro 4.7 kΩ	PRSL1891PI
		Potenziometro 10 kΩ	PRSL1892PI
		Potenziometro 1 kΩ	PRSL1893PI

### ACTUATORS

REF	DRAWING	DESCRIPTION	CODE
19+17+4		Blanking plug	PRSL1845PI
21		Disk for button	PRTAxxxxx see Disk table
22+4		2 speed pushbutton (for disk)	PRSL1810PI
		1 speed pushbutton (for disk)	PRSL1811PI
		1 speed illuminated pushbutton (for disk)	PRSL1815PI
33+4		1 speed black pushbutton	PRSL1806PI
		1 speed grey pushbutton	PRSL1807PI
		2 speed black pushbutton	PRSL1808PI
		2 speed grey pushbutton	PRSL1809PI

### PILOT LIGHTS

REF	DRAWING	COLOR	CODE
24+17+4		White	PRSL1844PI
		Green	PRSL1841PI
		Blue	PRSL1846PI
		Red	PRSL1840PI
		Yellow	PRSL1842PI
		Orange	PRSL1843PI

The data and the products illustrated in this brochure may be modified without notice. Under no circumstances can their description have a contractual value.



**TER Tecno Elettrica Ravasi srl**





Via Garibaldi 29/31 - 23885 Calco (LC) - Italy

Registered Office - via San Vigilio 2 - 23887 Olgiate Molgora (LC) - Italy

Tel. +39 0399911011 - Fax +39 0399910445 - E-mail: info@terworld.com

[www.terworld.com](http://www.terworld.com)

## MUSHROOM PUSHBUTTONS

REF	DRAWING	DESCRIPTION	HEAD COLOR	CODE
13+17+4		Latched mushroom pushbutton for emergency stop	Rosso	PRSL1880PI
14+17+4		Latched mushroom pushbutton for emergency stop Ø 40 mm	Red	PRSL1881PI
15+17+4		Key mushroom pushbutton	Red	PRSL1890PI
16+17+4		Impulse mushroom pushbutton with black base	Red	PRSL1885ROC
			Blue	PRSL1885BLC
			Yellow	PRSL1885GIC
			Green	PRSL1885VEC
			Orange	PRSL1885ARC
			Black	PRSL1885NEC
18+17+4		Rectangular Mushroom pushbutton (available only for Victor with 1 buttons)	Red	PRSL1882PI
			Black	PRSL1882NEC

## KEY SELECTOR SWITCHES

REF	DRAWING	POSITIONS	SPRING RETURN	MAINTAINED POSITIONS	PULL-OUT POSITION	CODE
20+17+4		0 / 1	X		0	PRSL1867PI
				X	0	PRSL1868PI
		1 / 0 / 1+2	X		0	PRSL1869PI
				X	0	PRSL1870PI
		0 / 1 / 1+2	X		0	PRSL1871PI
				X	0	PRSL1872PI
		1 / 2 change over	X		1	PRSL1873PI
				X	1	PRSL1874PI
		X		1+2	PRSL1875PI	
		1 / 1+2 / 2		X	1+2	PRSL1876PI

REF	DRAWING	POSITIONS	COLOR		CODE
			TRANSPARENT	FULL	
23+17+4		0 / 1 Spring return	White		PRSL1855BI
			Green		PRSL1855VE
			Blue		PRSL1855BL
			Red		PRSL1855RO
			Yellow		PRSL1855GI
			Orange		PRSL1855AR
		0 / 1 Maintained	White		PRSL1856BI
			Green		PRSL1856VE
			Blue		PRSL1856BL
			Red		PRSL1856RO
			Yellow		PRSL1856GI
			Orange		PRSL1856AR
		0 / 1 Spring return		White	PRSL1855BIC
				Green	PRSL1855VEC
				Blue	PRSL1855BLC
				Red	PRSL1855ROC
				Yellow	PRSL1855GIC
				Orange	PRSL1855ARC
		0 / 1 Maintained		White	PRSL1856BIC
				Green	PRSL1856VEC
				Blue	PRSL1856BLC
				Red	PRSL1856ROC
				Yellow	PRSL1856GIC
				Orange	PRSL1856ARC
		1 / 0 / 2 Spring return	White		PRSL1857BI
			Green		PRSL1857VE
			Blue		PRSL1857BL
			Red		PRSL1857RO
Yellow			PRSL1857GI		
Orange			PRSL1857AR		
1 / 0 / 2 Maintained	White		PRSL1858BI		
	Green		PRSL1858VE		
	Blue		PRSL1858BL		
	Red		PRSL1858RO		
	Yellow		PRSL1858GI		
	Orange		PRSL1858AR		
1 / 0 / 2 Spring return		White	PRSL1857BIC		
		Green	PRSL1857VEC		
		Blue	PRSL1857BLC		
		Red	PRSL1857ROC		
		Yellow	PRSL1857GIC		
		Orange	PRSL1857ARC		
1 / 0 / 2 Maintained		White	PRSL1858BIC		
		Green	PRSL1858VEC		
		Blue	PRSL1858BLC		
		Red	PRSL1858ROC		
		Yellow	PRSL1858GIC		
		Orange	PRSL1858ARC		

The data and the products illustrated in this brochure may be modified without notice. Under no circumstances can their description have a contractual value.



**TER Tecno Elettrica Ravasi srl**

Via Garibaldi 29/31 - 23885 Calco (LC) - Italy  
 Registered Office - via San Vigilio 2 - 23887 Olgiate Molgora (LC) - Italy  
 Tel. +39 0399911011 - Fax +39 0399910445 - E-mail: info@terworld.com

[www.terworld.com](http://www.terworld.com)







SELECTOR SWITCHES

REF	DRAWING	POSITIONS	COLOR		CODE
			TRANSPARENT	FULL	
23+17+4		1 / 1+2 / 2 Spring return	White		PRSL1863BI
			Green		PRSL1863VE
			Blue		PRSL1863BL
			Red		PRSL1863RO
			Yellow		PRSL1863GI
			Orange		PRSL1863AR
		1 / 1+2 / 2 Maintained	White		PRSL1864BI
			Green		PRSL1864VE
			Blue		PRSL1864BL
			Red		PRSL1864RO
			Yellow		PRSL1864GI
			Orange		PRSL1864AR
		1 / 1+2 / 2 Spring return		White	PRSL1863BIC
				Green	PRSL1863VEC
				Blue	PRSL1863BLC
				Red	PRSL1863ROC
				Yellow	PRSL1863GIC
				Orange	PRSL1863ARC
		1 / 1+2 / 2 Maintained		White	PRSL1864BIC
				Green	PRSL1864VEC
				Blue	PRSL1864BLC
				Red	PRSL1864ROC
				Yellow	PRSL1864GIC
				Orange	PRSL1864ARC
0 / 1 / 1+2 Spring return	White		PRSL1859BI		
	Green		PRSL1859VE		
	Blue		PRSL1859BL		
	Red		PRSL1859RO		
	Yellow		PRSL1859GI		
	Orange		PRSL1859AR		
0 / 1 / 1+2 Maintained	White		PRSL1860BI		
	Green		PRSL1860VE		
	Blue		PRSL1860BL		
	Red		PRSL1860RO		
	Yellow		PRSL1860GI		
	Orange		PRSL1860AR		
0 / 1 / 1+2 Spring return		White	PRSL1859BIC		
		Green	PRSL1859VEC		
		Blue	PRSL1859BLC		
		Red	PRSL1859ROC		
		Yellow	PRSL1859GIC		
		Orange	PRSL1859ARC		
0 / 1 / 1+2 Maintained		White	PRSL1860BIC		
		Green	PRSL1860VEC		
		Blue	PRSL1860BLC		
		Red	PRSL1860ROC		
		Yellow	PRSL1860GIC		
		Orange	PRSL1860ARC		

**SELECTOR SWITCHES**

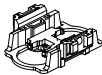
REF	DRAWING	POSITIONS	COLOR		CODE	
			TRANSPARENT	FULL		
23+17+4		1 / 2 Spring return	White		PRSL1861BI	
			Green		PRSL1861VE	
			Blue		PRSL1861BL	
			Red		PRSL1861RO	
			Yellow		PRSL1861GI	
			Orange		PRSL1861AR	
		1 / 2 Maintained	White		PRSL1862BI	
			Green		PRSL1862VE	
			Blue		PRSL1862BL	
			Red		PRSL1862RO	
			Yellow		PRSL1862GI	
			Orange		PRSL1862AR	
		1 / 2 Spring return		White		PRSL1861BIC
				Green		PRSL1861VEC
				Blue		PRSL1861BLC
				Red		PRSL1861ROC
				Yellow		PRSL1861GIC
				Orange		PRSL1861ARC
		1 / 2 Maintained		White		PRSL1862BIC
				Green		PRSL1862VEC
				Blue		PRSL1862BLC
				Red		PRSL1862ROC
				Yellow		PRSL1862GIC
				Orange		PRSL1862ARC

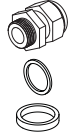
**ACCESSORIES**

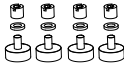
REF	DRAWING	DESCRIPTION	CODE
2		Label sheet - symbols	PRET0215PE
		Label sheet - German	PRET0220DE
		Label sheet - English	PRET0220EN
		Label sheet - Spanish	PRET0220ES
		Label sheet - French	PRET0220FR
		Label sheet - Italian	PRET0220IT
5		Mechanical interlock	PRSL1850PI
6		Button-switch spacer	PRSL8512PI
10 + 11 + 25		Cable clamp M20x1.5 + rings	PRSL1837PI
26		1-2-3 switch holder	PRSL8750PI
27		Magnetic mounting kit	PRSL1851PI

The data and the products illustrated in this brochure may be modified without notice. Under no circumstances can their description have a contractual value.









**TER Tecno Elettrica Ravasi srl**

Via Garibaldi 29/31 - 23885 Calco (LC) - Italy  
 Registered Office - via San Vigilio 2 - 23887 Olgiate Molgora (LC) - Italy  
 Tel. +39 0399911011 - Fax +39 0399910445 - E-mail: info@terworld.com

[www.terworld.com](http://www.terworld.com)



## EMPTY CONTROL STATIONS

	N. OF BUTTONS	GREY UPPER COVER	YELLOW UPPER COVER	BLACK UPPER COVER	CODE
	1	X			F71EG00000000001
			X		F71EY00000000001
				X	F71EB00000000001
	2	X			F71FG00000000001
			X		F71FY00000000001
				X	F71FB00000000001
	3	X			F71GG00000000001
			X		F71GY00000000001
				X	F71GB00000000001
	4	X			F71HG00000000001
				X	F71HB00000000001
	6	X			F71IG00000000001
				X	F71IB00000000001
	8	X			F71JG00000000001
				X	F71JB00000000001

The data and the products illustrated in this brochure may be modified without notice. Under no circumstances can their description have a contractual value.



**TER Tecno Elettrica Ravasi srl**

Via Garibaldi 29/31 - 23885 Calco (LC) - Italy

Registered Office - via San Vigilio 2 - 23887 Olgiate Molgora (LC) - Italy









Tel. +39 0399911011 - Fax +39 0399910445 - E-mail: info@terworld.com

**www.terworld.com**



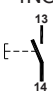

# STANDARD CONTROL STATIONS

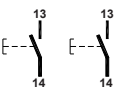
Standard control stations are supplied with a cable clamp.



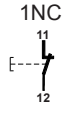
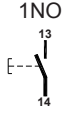

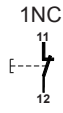
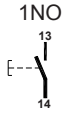

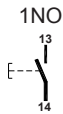
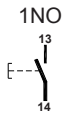
## 1 ACTUATOR

	TYPE OF ACTUATOR	GREY	YELLOW	BLACK	CODE
		UPPER COVER	UPPER COVER	UPPER COVER	
	Latched mushroom pushbutton PRSL1801PI switch 1NC 	X			F71EG1000000001
			X		F71EY1000000001
				X	F71EB1000000001
	Key mushroom pushbutton PRSL1801PI switch 1NC 	X			F71EG1000000002
			X		F71EY1000000002
				X	F71EB1000000002
	Impulse mushroom pushbutton PRSL1801PI switch 1NC 	X			F71EG1000000003
			X		F71EY1000000003
				X	F71EB1000000003
	2 positions selector switches PRSL1800PI switch 1NO 	X			F71EG00000001001
			X		F71EY00000001001
				X	F71EB00000001001
	3 positions selector switches N.2 PRSL1800PI switches 1NO + 1 NO 	X			F71EG00000001002
			X		F71EY00000001002
				X	F71EB00000001002

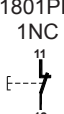
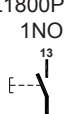
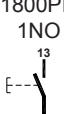
## 2 ACTUATORS

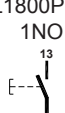
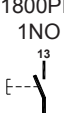
TYPE OF ACTUATORS			GREY UPPER COVER	YELLOW UPPER COVER	BALCK UPPER COVER	CODE
	Latched mushroom pushbutton PRSL1801PI switch 1NC 	Start button PRSL1800PI switch 1NO 	X			F71FG11000000001
				X		F71FY11000000001
					X	F71FB11000000001
	Key mushroom pushbutton PRSL1801PI switch 1NC 	Start button PRSL1800PI switch 1NO 	X			F71FG11000000002
				X		F71FY11000000002
					X	F71FB11000000002
	White button PRSL1800PI switch 1NO 	Black button PRSL1800PI switch 1NO 	X			F71FG00020000001
				X		F71FY00020000001
					X	F71FB00020000001

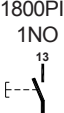
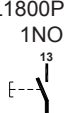
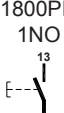
## 3 ACTUATORS

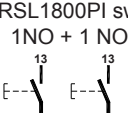
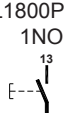
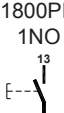
TYPE OF ACTUATORS			GREY UPPER COVER	YELLOW UPPER COVER	BALCK UPPER COVER	CODE	
	Latched mushroom pushbutton PRSL1801PI switch 1NC 	White button PRSL1800PI switch 1NO 	Black button PRSL1800PI switch 1NO 	X		F71GG10020000001	
					X		F71GY10020000001
						X	F71GB10020000001
	Key mushroom pushbutton PRSL1801PI switch 1NC 	White button PRSL1800PI switch 1NO 	Black button PRSL1800PI switch 1NO 	X		F71GG10020000002	
					X		F71GY10020000002
						X	F71GB10020000002
	2 positions selector switches PRSL1800PI switch 1NO 	White button PRSL1800PI switch 1NO 	Black button PRSL1800PI switch 1NO 	X		F71GG00020001001	
					X		F71GY00020001001
						X	F71GB00020001001
	3 positions selector switches N.2 PRSL1800PI switches 1NO + 1 NO 	White button PRSL1800PI switch 1NO 	Black button PRSL1800PI switch 1NO 	X		F71GG00020001002	
					X		F71GY00020001002
						X	F71GB00020001002

The data and the products illustrated in this brochure may be modified without notice. Under no circumstances can their description have a contractual value.



**TER Tecno Elettrica Ravasi srl**

Via Garibaldi 29/31 - 23885 Calco (LC) - Italy

Registered Office - via San Vigilio 2 - 23887 Olgiate Molgora (LC) - Italy

Tel. +39 0399911011 - Fax +39 0399910445 - E-mail: info@terworld.com

[www.terworld.com](http://www.terworld.com)



## 1 VICTOR - Legend - Control elements

### \* SWITCH ACTIVATION

It is possible to mount up to 3 switches for each control element. The chart on the right of each pushbutton or selector switch specifies which position activates the switch on the top, in the middle or on the bottom. If the selector switches are mounted with the lever facing downwards, then the activation of the switches is reversed. Eg.: 2 speed pushbutton: the first speed activates the switches on the top and in the middle, while the second speed activates the switch on the bottom.

### Pushbuttons

It is possible to mount up to three switches for each button. LEDs can be mounted only in the middle.

		SWITCH ACTIVATION*
1	1 speed pushbutton with disk	<input type="checkbox"/> speed 1
25	1 speed black pushbutton	<input type="checkbox"/> speed 1
26	1 speed grey pushbutton	<input type="checkbox"/> speed 1
2	2 speed pushbutton with disks	<input type="checkbox"/> speed 1 <input type="checkbox"/> speed 2
27	2 speed black pushbutton	<input type="checkbox"/> speed 1 <input type="checkbox"/> speed 2
28	2 speed grey pushbutton	<input type="checkbox"/> speed 1 <input type="checkbox"/> speed 2
3	1 speed illuminated pushbutton with disk	<input type="checkbox"/> speed 1 <input type="checkbox"/> LED <input type="checkbox"/> speed 1

### Mushroom pushbuttons

All mushroom pushbuttons activate all the switches at the same time.

- 4 Latched mushroom pushbutton for emergency stop
- 5 Latched mushroom pushbutton for emergency stop Ø 40 mm
- 6 Key mushroom pushbutton
- 7 Impulse mushroom pushbutton with black base
- 8 Rectangular red mushroom pushbutton
- 9 Rectangular black mushroom pushbutton

### 11 Pilot light

### 12 Blanking plug

### Toggle selector switches

It is possible to mount only two switches for each selector. In the middle it is possible to mount only the LED for illuminated selector switches.

		SWITCH ACTIVATION*
15	0 / 1 spring return	<input type="checkbox"/> pos 1 <input type="checkbox"/> pos 1
16	0 / 1 maintained positions	<input type="checkbox"/> pos 1 <input type="checkbox"/> pos 1
17	1 / 0 / 2 spring return	<input type="checkbox"/> pos 1 <input type="checkbox"/> pos 2
18	1 / 0 / 2 maintained positions	<input type="checkbox"/> pos 1 <input type="checkbox"/> pos 2
19	1 / 1+2 / 2 spring return	<input type="checkbox"/> pos 1 and 1+2 <input type="checkbox"/> pos 2 and 1+2
20	1 / 1+2 / 2 maintained positions	<input type="checkbox"/> pos 1 and 1+2 <input type="checkbox"/> pos 2 and 1+2
21	0 / 1 / 1+2 spring return	<input type="checkbox"/> pos 1+2 <input type="checkbox"/> pos 1 and 1+2
22	0 / 1 / 1+2 maintained positions	<input type="checkbox"/> pos 1+2 <input type="checkbox"/> pos 1 and 1+2
23	1 / 2 spring return	<input type="checkbox"/> pos 1 <input type="checkbox"/> pos 2
24	1 / 2 maintained positions	<input type="checkbox"/> pos 1 <input type="checkbox"/> pos 2

### Key selector switches

It is possible to mount only two switches for each selector, and no switch/LED in the central position.

		SWITCH ACTIVATION*
30	0 / 1 spring return key out in position 0	<input type="checkbox"/> pos 1 NA <input type="checkbox"/> pos 1
31	0 / 1 maintained positions key out in position 0	<input type="checkbox"/> pos 1 NA <input type="checkbox"/> pos 1
32	1 / 0 / 2 spring return key out in position 0	<input type="checkbox"/> pos 1 NA <input type="checkbox"/> pos 2
33	1 / 0 / 2 maintained positions key out in position 0	<input type="checkbox"/> pos 1 NA <input type="checkbox"/> pos 2
34	0 / 1 / 1+2 spring return key out in position 0	<input type="checkbox"/> pos 1+2 NA <input type="checkbox"/> pos 1 and 1+2
35	0 / 1 / 1+2 maintained positions key out in position 0	<input type="checkbox"/> pos 1+2 NA <input type="checkbox"/> pos 1 and 1+2
36	1 / 2 change-over spring return key out in position 1	<input type="checkbox"/> pos 1 NA <input type="checkbox"/> pos 2
37	1 / 2 change-over maintained positions key out in position 1	<input type="checkbox"/> pos 1 NA <input type="checkbox"/> pos 2
38	1 / 1+2 / 2 spring return key out in position 1+2	<input type="checkbox"/> pos 1 and 1+2 NA <input type="checkbox"/> pos 2 and 1+2
39	1 / 1+2 / 2 maintained positions key out in position 1+2	<input type="checkbox"/> pos 1 and 1+2 NA <input type="checkbox"/> pos 2 and 1+2

## 2 Legend - Button disks and colors

### Full color and symbol disks for pushbuttons (ref. 1 and 2)

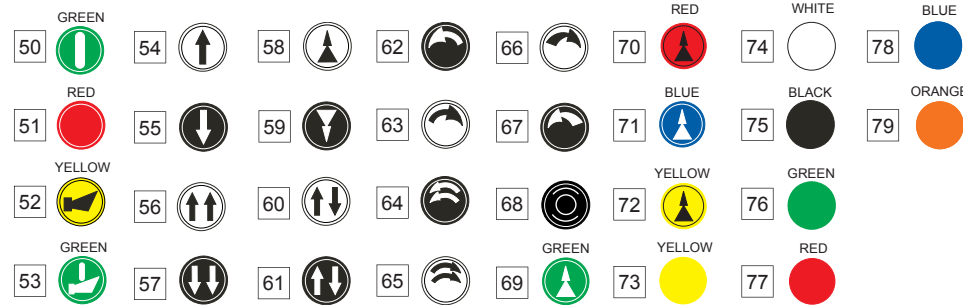

### Transparent disks for illuminated buttons (ref. 3)

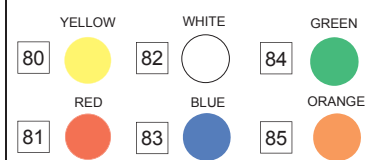

## 3 Legend - Color of selectors, mushrooms, pilot lights

### Non-illuminated toggle selector switches (ref. 15 to 24)

RP	Red	BP	Blue	AP	Orange
GP	Yellow	VP	Green	WP	White

### Illuminated toggle selector switches (ref. 15 to 24)

RI	Red	BI	Blue	AI	Orange
GI	Yellow	VI	Green	WI	White

### Impulse mushroom pushbutton with black base (ref. 7)

R	Red	B	Blue	A	Orange
G	Yellow	V	Green	N	Black

### Pilot lights (ref. 11)

R	Red	B	Blue	A	Orange
G	Yellow	V	Green	W	White

## 5 Legend - Switches LEDs and potentiometers

- 90 PRSL1800PI - 1NO switch
- 91 PRSL1801PI - 1NC switch
- 92 PRSL1820PI LED 24/48 V AC/DC
- 93 PRSL1821PI LED 110/230 V AC
- 94 PRSL1891PI potentiometer 4.7 kΩ
- 95 PRSL1892PI potentiometer 10 kΩ
- 96 PRSL1893PI potentiometer 1 kΩ

The data and the products illustrated in this brochure may be modified without notice. Under no circumstances can their description have a contractual value.



**TER Tecno Elettrica Ravasi srl**

Via Garibaldi 29/31 - 23885 Calco (LC) - Italy

Registered Office - via San Vigilio 2 - 23887 Olgiate Molgora (LC) - Italy

Tel. +39 0399911011 - Fax +39 0399910445 - E-mail: info@terworld.com

[www.terworld.com](http://www.terworld.com)



## USE AND MAINTENANCE INSTRUCTIONS

Victor Wall-mounted Control Station is an electromechanical device for low voltage control circuits (EN 60947-1, EN 60947-5-1) to be used as electrical equipment on machines (EN 60204-1) in compliance with the fundamental requirements of the Low Voltage Directive 2006/95/CE and of the Machine Directive 2006/42/CE.

The control station is designed for industrial use and also for use under particularly severe climatic conditions (operational temperature from  $-40^{\circ}\text{C}$  to  $+80^{\circ}\text{C}$ , suitable for use in tropical environment). The equipment is not suitable for use in environments with potentially explosive atmosphere, corrosive agents or a high percentage of sodium chloride (saline fog). Oils, acids or solvents may damage the equipment; avoid using them for cleaning.

Do not connect more than one phase to each switch. Do not oil or grease the control elements or the switches.

The installation of the control station shall be carried out by expert and trained personnel. Wiring shall be properly done according to the current instructions.

Prior to the installation and the maintenance of the control station, the main power of the machinery shall be turned off.

### Steps for the proper installation of the control station

1. Open the control station.
2. Break the seat chosen for the cable clamp on the base (7) making sure to remove any burr; in Victor 1 remove the switch support first (9).
3. If you choose the bottom seats in Victor 1, fit the washer (10) (Victor 2-3-4-6-8 do not require washers in the bottom seats). For all control station Victor 1-2-3-4-6-8, if you choose the side seats fit the washer (5) and tighten the cable clamp (6).
4. Fasten the control station on the desired support, making sure to match the spacing of the fixing holes on the base (7). Use M4 screws and check that the equipment is properly fastened. Use only the special fixing holes to fasten the control station.
5. Insert the multi-pole cable into the control station through the cable clamp (6). Strip the cable to a length suitable for wiring the switches/LED (8).
6. Tape the stripped part of the cable.
7. Tighten the cable clamp (6) to fasten the multi-pole cable.
8. Connect all the switches/LED (8) according to the wiring layout printed on the switches/LED and overleaf (tighten the wires into the terminals with a torque equal to 0.5 Nm; (UL (c)UL: use  $60^{\circ}\text{C}$  or  $75^{\circ}\text{C}$  copper (CU) conductors and stiff or flexible wire 14-16 AWG); insertability of wires into the terminals:  $2 \times 0.5 \text{ mm}^2$  -  $2 \times 1.5 \text{ mm}^2$  -  $1 \times 2.5 \text{ mm}^2$ ).
9. Close the control station checking the proper positioning of the tightening gasket (4), making sure the gasket fits well into the cover and the base seats. ATTENTION: make sure that cover and base are positioned in the proper direction. Make sure no cable is in between the switches/LED (8) and the actuators mounted on the upper cover (1). Tighten the fixing screws (3) on the cover (1) with a torque of 250 cNm.

CAUTION: Do not operate on the actuators when the control station is not perfectly closed (with screws tightened and clips fitted as described in point 9) as this may cause the release of the mechanical interlock. If this happens, re-position the mechanical interlock before closing the control station.

### Periodic maintenance steps

- Check the proper tightening of the screws (3) of the enclosure (1, 7).
- Check the proper tightening of the switch/LED (8) terminal screws.
- Check the wiring conditions (in particular where wires clamp into the switches).
- Check the conditions of the tightening gasket (4), of the rubber of the actuators (2) and of the cable clamp (6).
- Check that the plastic enclosure (1, 7) of the control station is not broken.
- Check that the control station is properly fastened.

In case any component of the pendant station is modified, the validity of the markings and the guarantee on the equipment are annulled. Should any component need replacement, use original spare parts only.

TER declines all responsibility for damages caused by the improper use or installation of the equipment.

## Specifications UL

### Technical Specifications UL

Code Victor certified UL = F81XXXXXXXXXXXXXXXXX  
= F82XXXXXXXXXXXXXXXXX

Category = NKCR / NKCR7

Contact Blocks Rating = A600, Q600

LED PRSL1821PI Rating = 110 – 240VAC, 1.15 – 2.50 mA

LED PRSL1820PI Rating = 24 – 48 VDC/AC, 1.30 – 2.70 mA

Environmental Rating (Victor grey and black) = Type 1, 4 and 4X

Environmental Rating (Victor yellow) = Type 1, 4 and 4X indoor use only

Cord diameter range = F81xx from 0.39 in (10mm) to 0.55 in (14mm)  
= F82xx from 0.24 in (6mm) to 0.47 in (12mm)

Cord type = flexible, type minimum SW or SJW (ZJCZ/7)

Wire size Range = 14-16 AWG stranded or solid

Conductors = Copper (CU) 60/75°C

Terminal tightening torque = 4.50 lb.in (0.5Nm)

Marking =  05

### Emergency Stop Button

Category = NISD3

Code = PRSL1880P1, PRSL1881PI

Contact Blocks = PRSL1801PI (A600, Q600)

Optional Contact Blocks = PRSL1800PI (A600, Q600)

Code = PRSL1890PI

Contact Blocks = PRSL1801PI (A600, Q600)

These unlisted component emergency stop buttons are intended for use within TECNO ELETTRICA RAVASI S R L Listed (NKCR) Mike and Victor pushbutton stations.

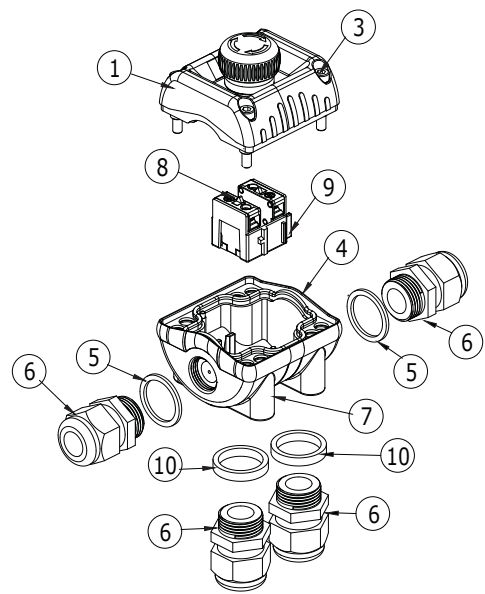
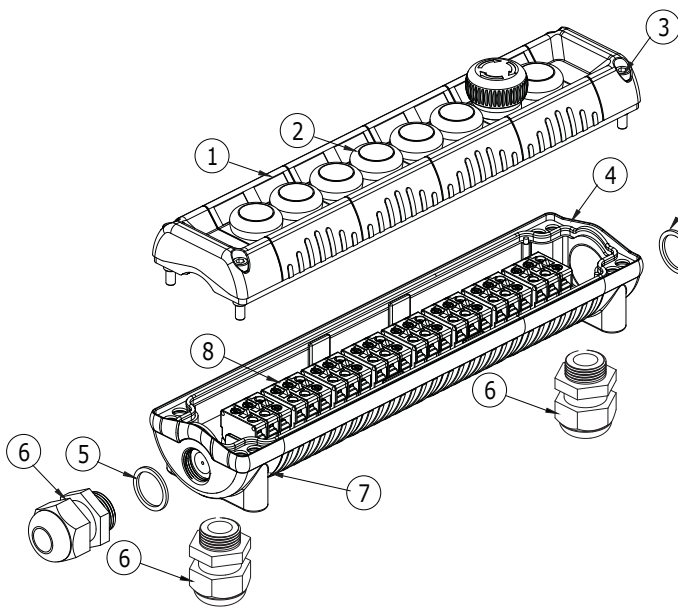

### SWITCH ACTIVATION

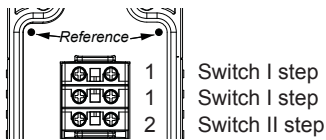

Pushbutton 2 steps

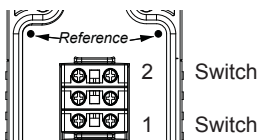

Selector 0/1/1+2

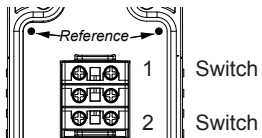

Selector 1/0/2  
Selector 1/1+2/2  
Selector 1/2

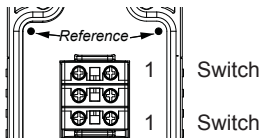

Selector 0/1

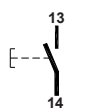

1NO switch

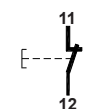

1NC switch



LED

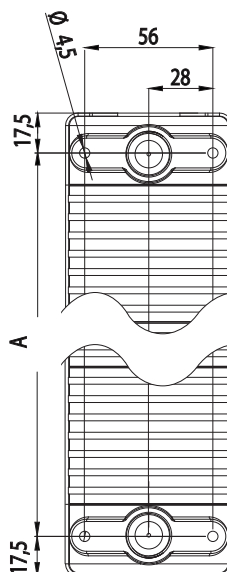

N° of buttons	Length (mm)	
	A	
1	37,9	
2	87	
3	117	
4	147	
6	207	
8	267	

The data and the products illustrated in this brochure may be modified without notice. Under no circumstances can their description have a contractual value.



**TER Tecno Elettrica Ravasi srl**

Via Garibaldi 29/31 - 23885 Calco (LC) - Italy

Registered Office - via San Vigilio 2 - 23887 Olgiate Molgora (LC) - Italy

Tel. +39 0399911011 - Fax +39 0399910445 - E-mail: info@terworld.com

[www.terworld.com](http://www.terworld.com)